

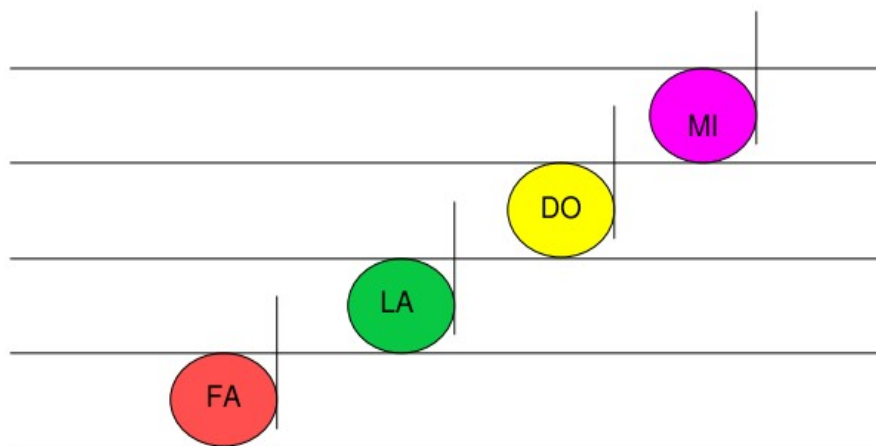

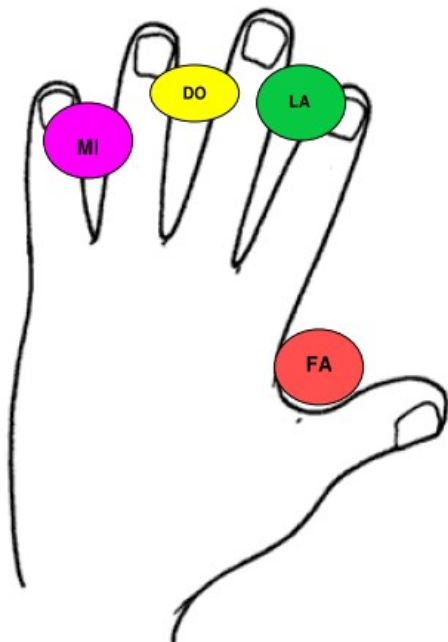

PENTAGRAMMA  
 HA 5 RIGHE E HA 4 SPAZI.  
 NELLE RIGHE TROVI LE SEGUENTI NOTE:

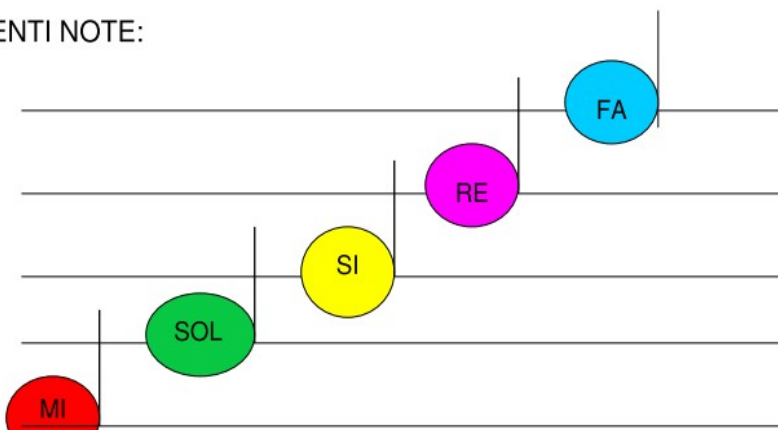
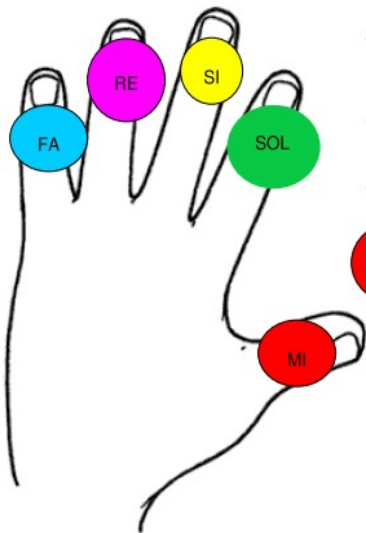

- |   |                                     |
|---|-------------------------------------|
|  | si trova tra il Pollice e indice    |
|  | si trova tra l'indice e il medio    |
|  | si trova tra il medio e l'annullare |
|  | si trova tra l'annullare e il medio |

PER LE NOTE BASSE RE E DO SONO SOTTO  
LE RIGHE DEL PENTAGRAMMA  
IL RE SOLO SOTTO  
IL DO E' TAGLIATA A META'

